











# First Floor

H Corbett Suite

H1 Rashwood Suite

H2 Ladywood Suite

## Key

-  Door
-  Column
-  Single socket
-  Dance floor
-  Double socket
-  Room partition
-  Triple socket
-  Balcony
-  Telephone point
-  Column
-  TV aerial

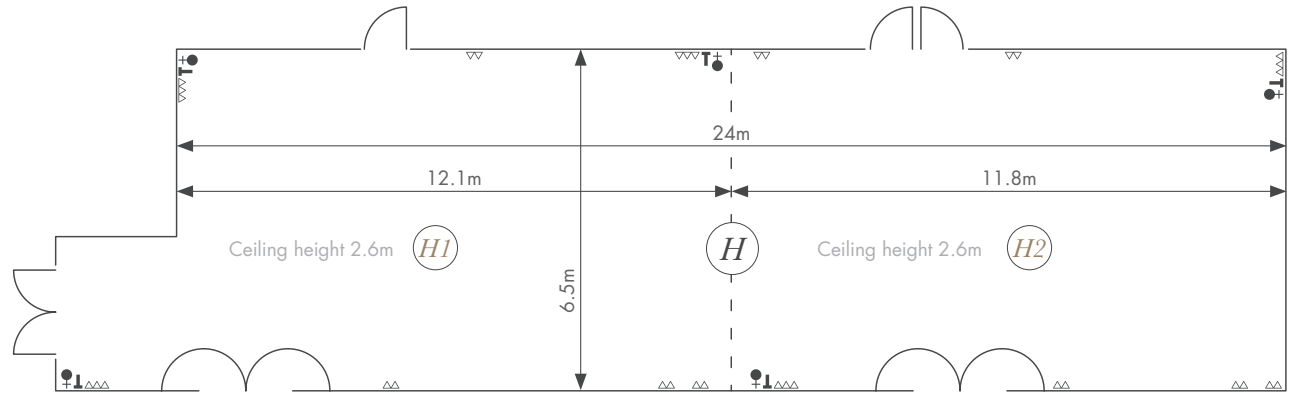

	Theatre		Classroom		Cabaret		Banquet		Open block	U-shape	Boardroom	Ceremony	Wedding Breakfast	Reception
	Front projection	Rear projection	Front projection	Rear projection	Front projection	Rear projection	Front projection	Rear projection						
<i>Corbett Suite</i>	200	200	100	100	96	96	-	-	100	80	90	-	-	-
<i>Rashwood Suite</i>	120	120	50	50	64	64	-	-	54	40	44	-	-	-
<i>Ladywood Suite</i>	88	88	40	40	48	48	-	-	46	30	36	-	-	-